

CUSTOM MANUFACTURED BASEBALL CAP STYLE DESIGN EXAMPLE

FRONT VIEW

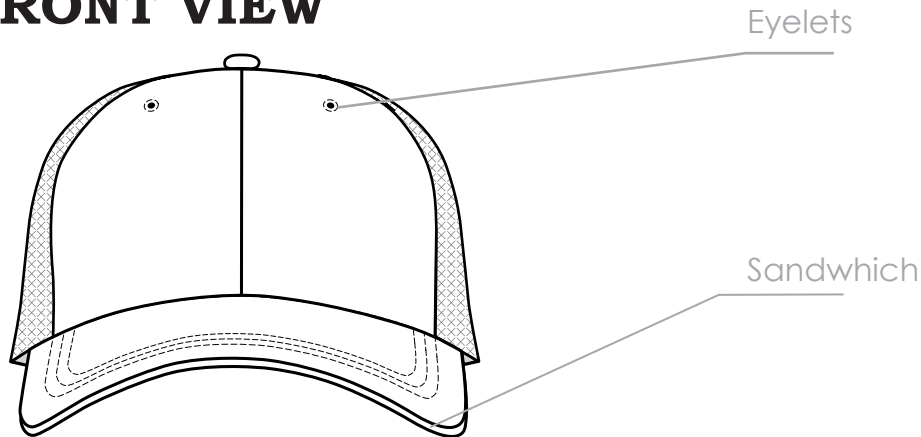

UNDER VIEW

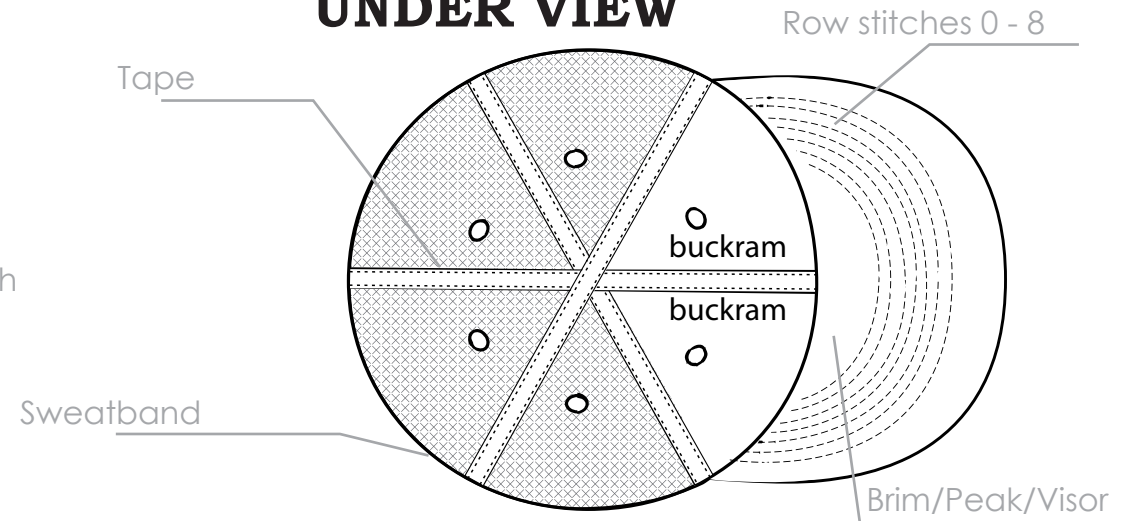

BACK VIEW

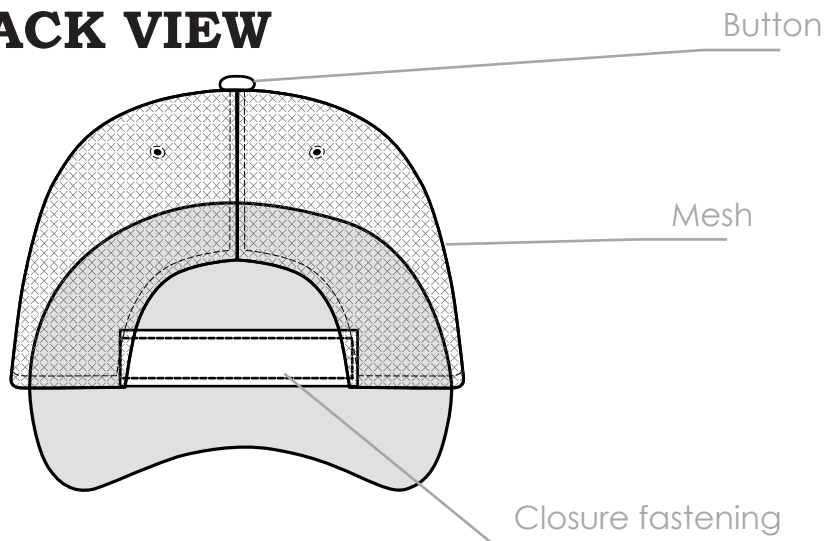

SIDE VIEW

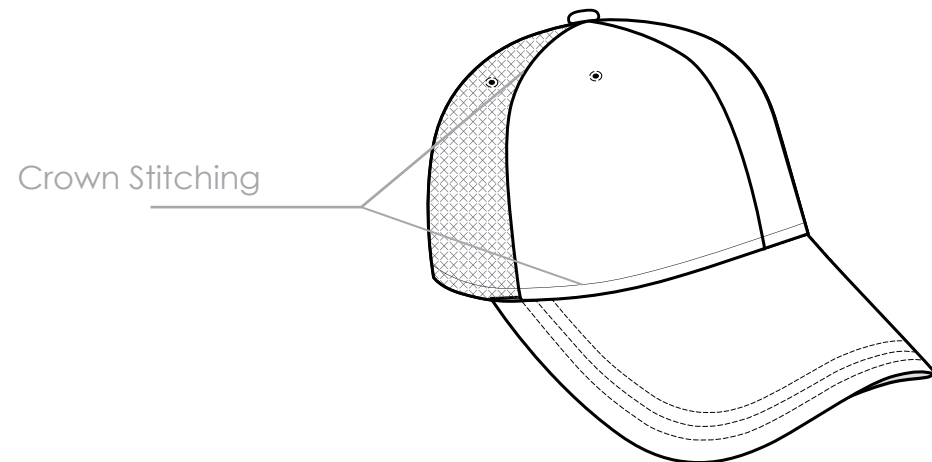

Crown Style

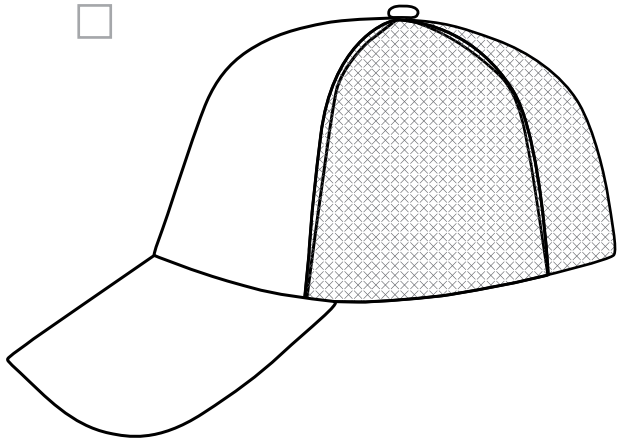

6 panels, double front

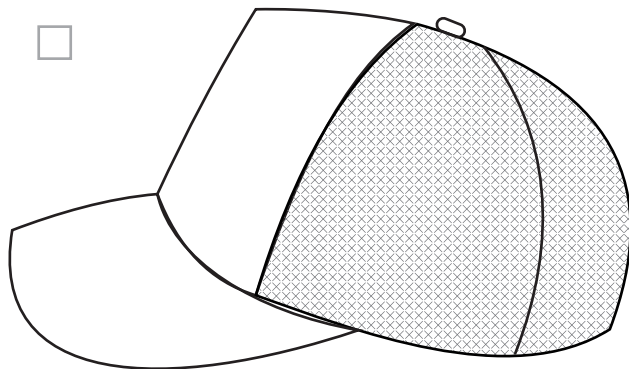

5 panels, Single front

Closure

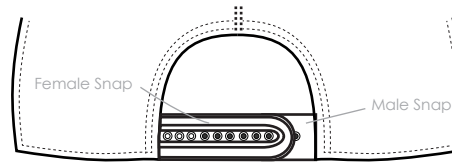
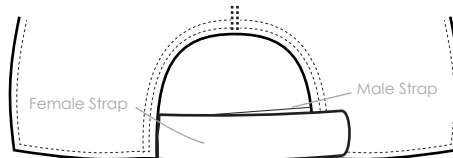
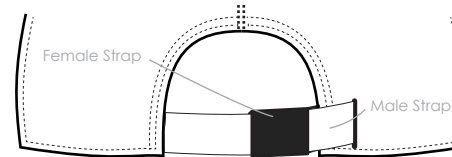
 plastic snap back

 velco strap closure

 fabric/leather and metal closure

Closure: COLOR: MATERIAL:

Female	<input type="checkbox"/>	Black	Standard
Male	<input type="checkbox"/>	Black	Standard



*Optional Metal closure Stamp

Brim

PANEL: COLOR / SWATCH: FABRIC:

TOP VISOR

G type pantone here 100% cotton twill

UNDER VISOR:

N type pantone here 100% cotton twill

TYPE OF BRIM: FLAT Pre-curved

STYLE OF BRIM:

- Regular Brim
- Sandwich | Color:
- Flip Visor

SHAPE OF BRIM:

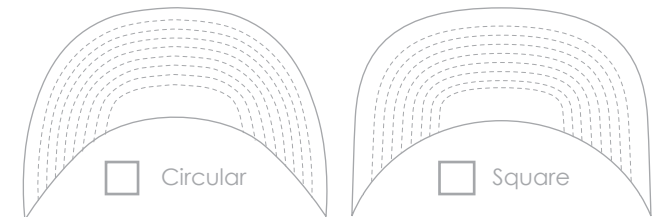

Number of Row stitches:

1 | 2 | 3 | 4 | 5 | 6 | 7 | 8

 Pre-Curved

 Flat

Order Number: 000001

Project Name: Blank Template

Exterior

PANEL:	COLOR / SWATCH:	FABRIC:
A	 Black	100% Cotton Twill
B	 Black	100% Cotton Twill
C	 Black	100% Nylon Mesh
D	 Black	100% Nylon Mesh
E	 Black	100% Nylon Mesh
F	 Black	100% Nylon Mesh

TOP BUTTON:

 type pantone here 100% cotton twill

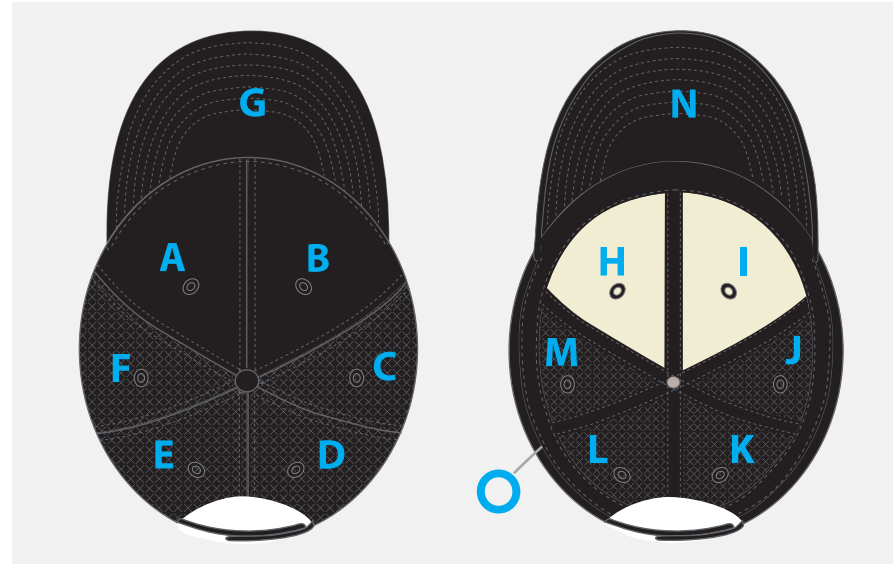

Sublimination

- A Yes, see attached art work
- B Yes, see attached art work
- C Yes, see attached art work
- D Yes, see attached art work
- E Yes, see attached art work
- F Yes, see attached art work
- G Yes, see attached art work
- N Yes, see attached art work







Interior Lining

PANEL:	COLOR / SWATCH:	FABRIC:
H	<input type="checkbox"/> -	-
I	<input type="checkbox"/> -	-
J	<input type="checkbox"/> -	-
K	<input type="checkbox"/> -	-
L	<input type="checkbox"/> -	-
M	<input type="checkbox"/> -	-

Pick one BUCKRAM: then pick one Double Single
 FOAM: Thin Thick

O - SWEATBAND: black 3mm wrapped foam

Eyelets

PANEL:	THREAD COLOR:
A	 to match panel color
B	 to match panel color
C	 to match panel color
D	 to match panel color
E	 to match panel color
F	 to match panel color

Crown Fitting

Shallow Medium Deep

Stitching

PANEL:	COLOR:
A	<input type="checkbox"/> to match panel
B	<input type="checkbox"/> to match panel
C	<input type="checkbox"/> to match panel
D	<input type="checkbox"/> to match panel
E	<input type="checkbox"/> to match panel
F	<input type="checkbox"/> to match panel

TOP VISOR:

G to match visor

UNDER VISOR:

N to match visor

(Optional) Front Clear Stitching

- A & B Center clear stitching
 Make stitching clear
- A & B Bottom clear stitching
 Make stitching clear

Order Number: 000001

Project Name: Blank Template

ADDITIONAL ARTWORK FILES:

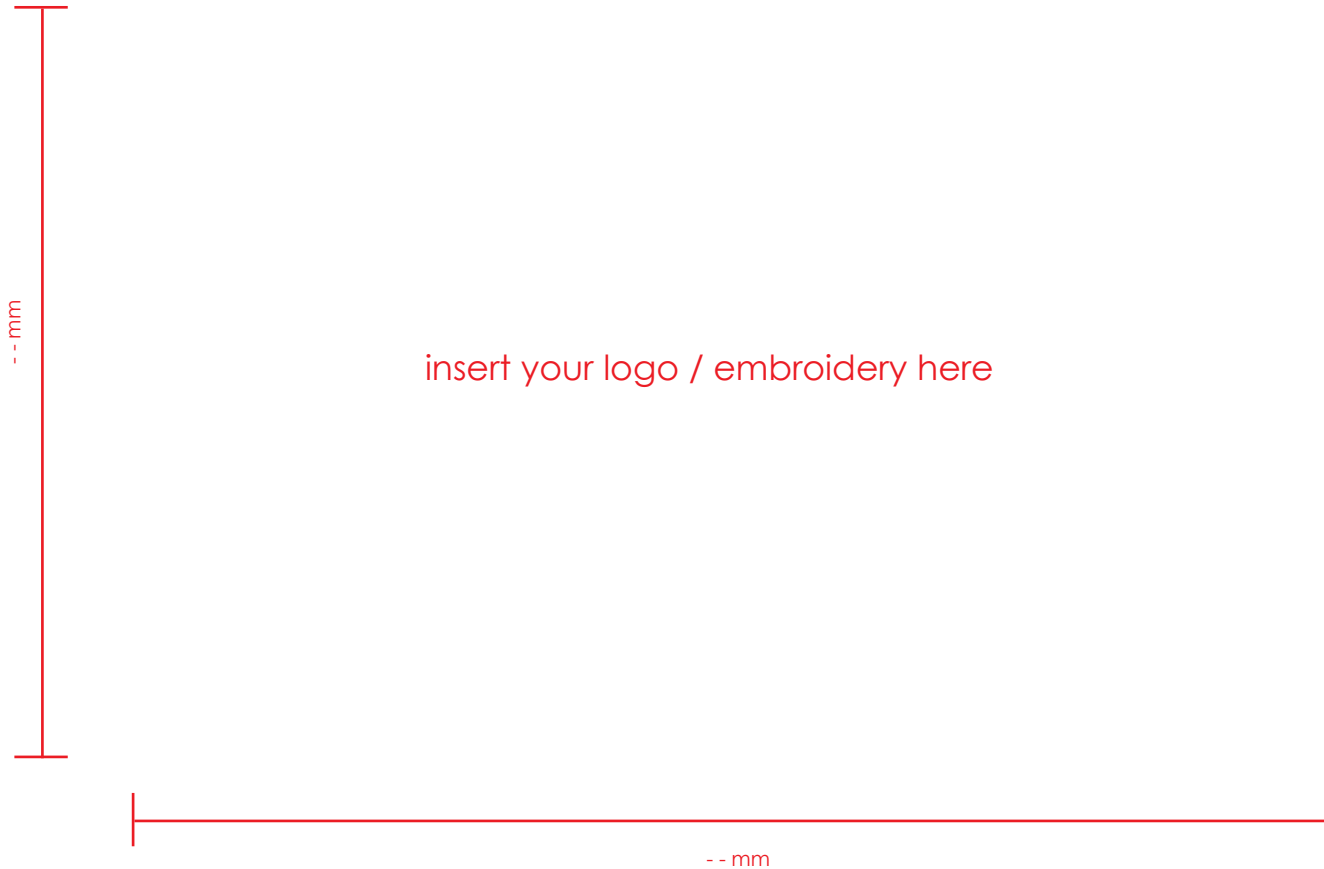

Front Panels

embroidery

EMBROIDERY TYPE: (3D / FLAT) SPECIFY THREAD COLORS:

- 3D type pantone here
- type pantone here
- type pantone here
- type pantone here

PLACEMENT:

Order Number: 000001

Project Name: Blank Template



Back and Side Panels

embroidery

EMBROIDERY TYPE: (3D / FLAT) SPECIFY THREAD COLORS:

- flat type pantone here
- type pantone here
- type pantone here
- type pantone here

PLACEMENT:

Other notes options, tags or addons.

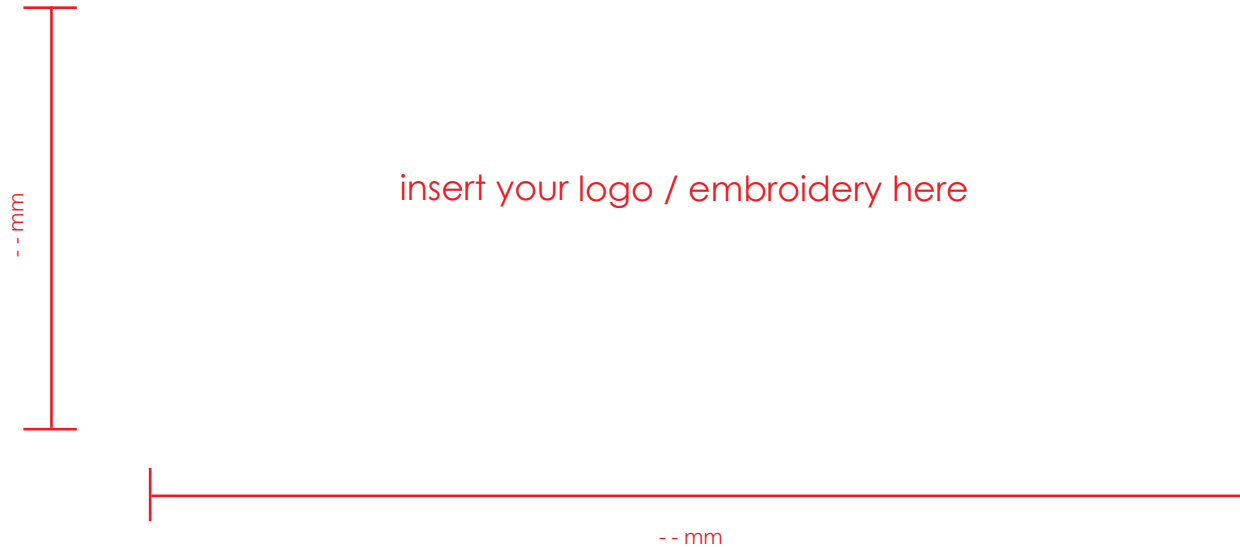

Custom panels

ADDITIONAL ARTWORK FILES:

If you have any custom fabric / prints please insert here. please also supply additional artwork file, with the art 100% to scale. If there is no panel customization, please just leave this section blank

visor top

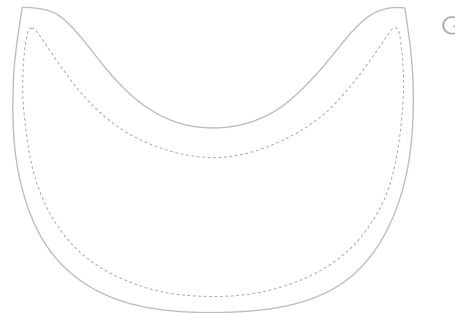

under visor

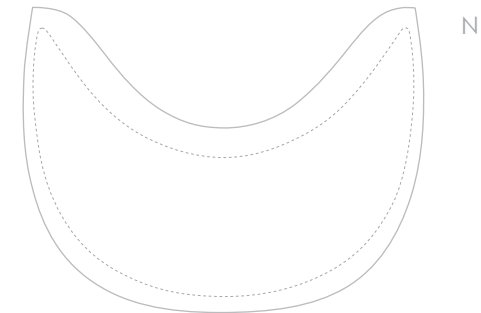

front

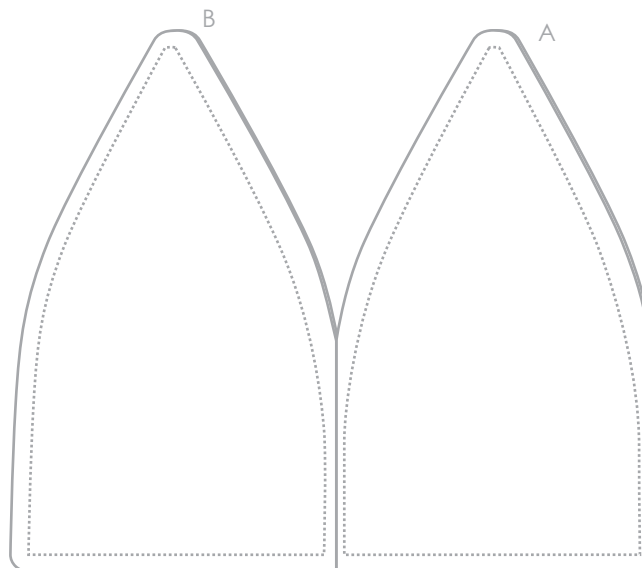

wearer's left

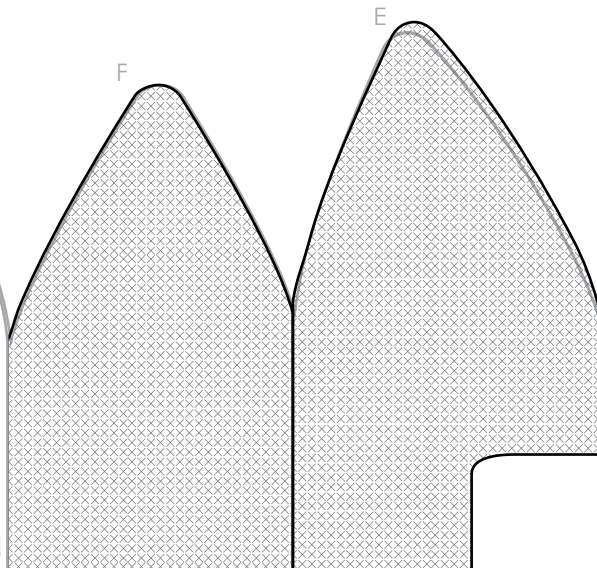

wearer's right

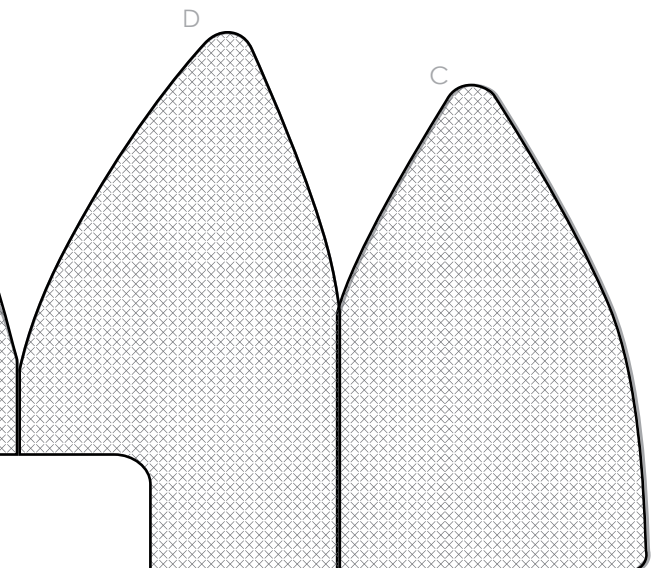



AUTHENTIC
CUSTOM | PRINTED
EST. 2015

Trucker CAP

Order Number: 000001

Project Name: Blank Template

Interior Taping

TAPING COLOR:



Black

SCREEN PRINT COLOR:



Type pantone here



Type pantone here



Additional Details

ADDITIONAL ARTWORK FILES:

Interior Labels

Cap Deals is a branded headwear manufacturer, At extra cost we can white label your tags. All headwear comes with our woven sweat band label if not white labeled.

Care Label



Use for sublimination and further design

*Please be aware of the area that will be stitched together and could effect design.
Try to keep high detail away from edges. Wrapped designs will be matched to the best of
our abilities.*

for 6 panel

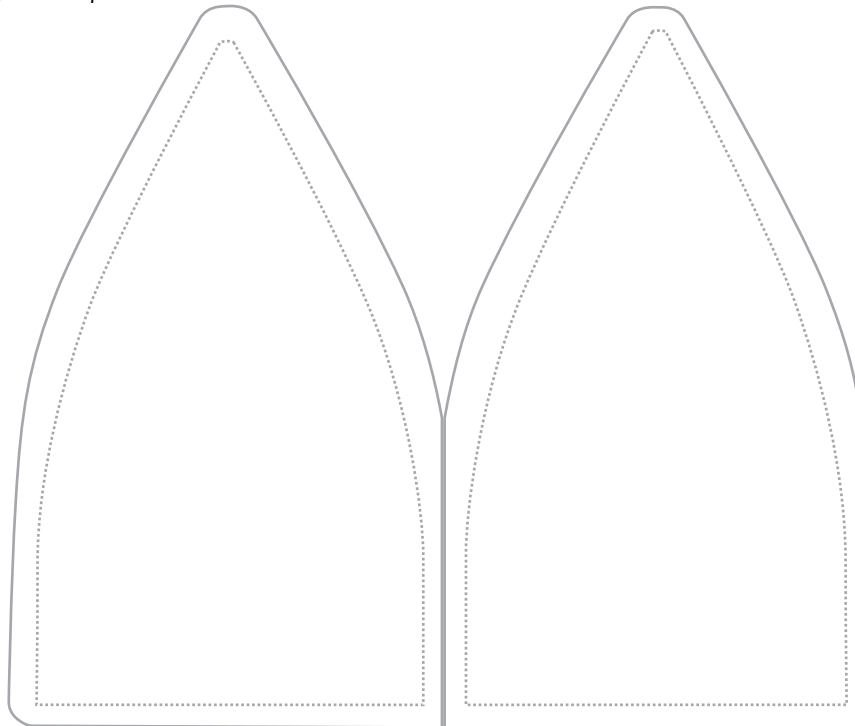

for 5 panel

