

CUSTOM MANUFACTURED BASEBALL CAP STYLE DESIGN EXAMPLE

FRONT VIEW

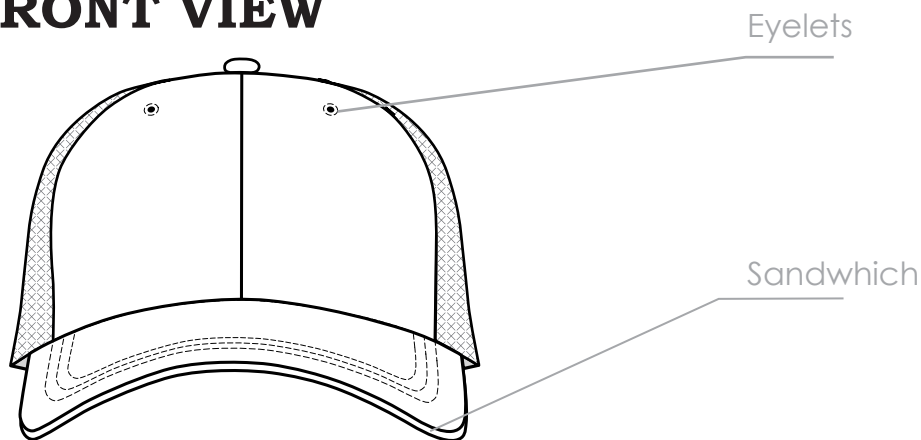

UNDER VIEW

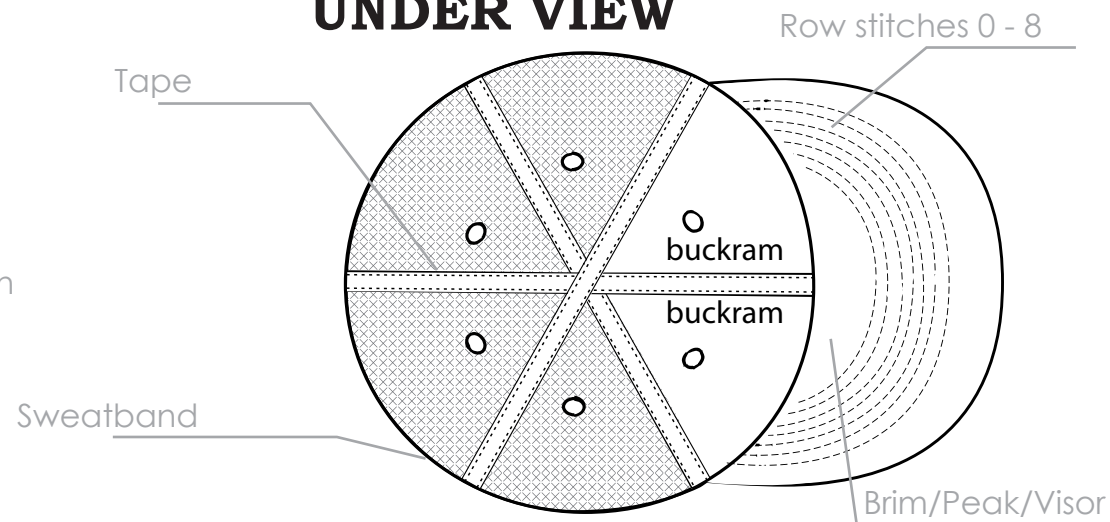

BACK VIEW

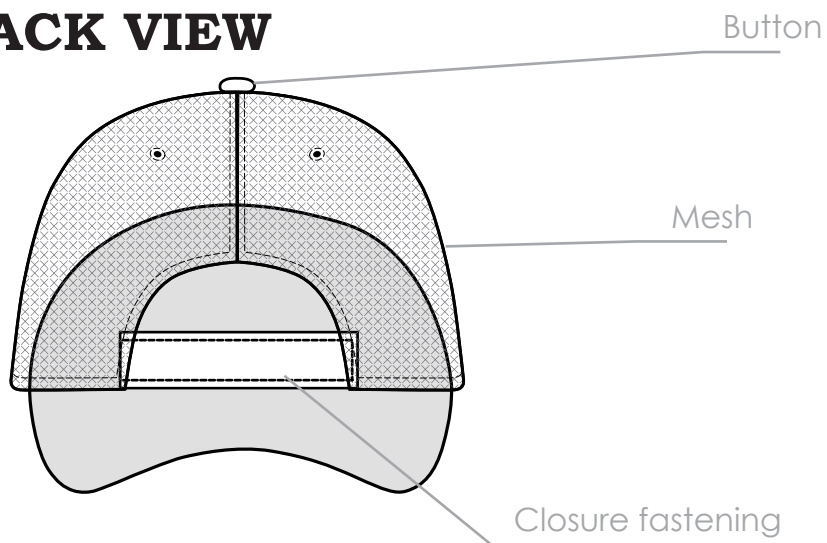

SIDE VIEW

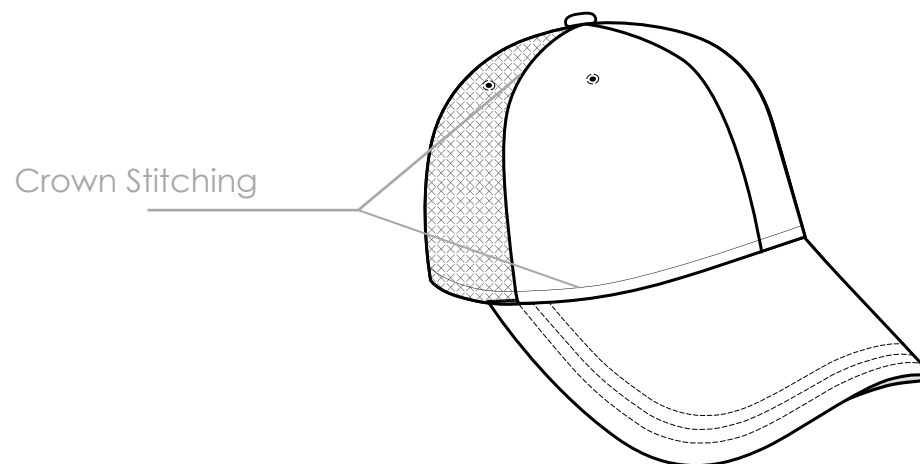

Crown Style

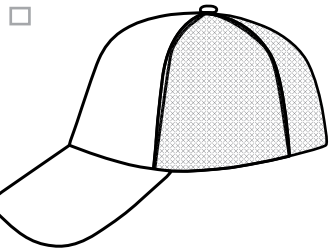

6 panels, double front (Medium Crown)

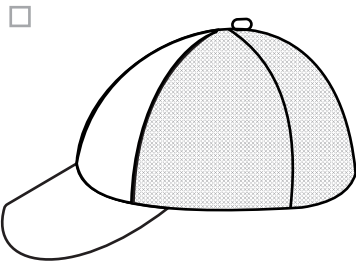

6 panels, double front (Low Crown)

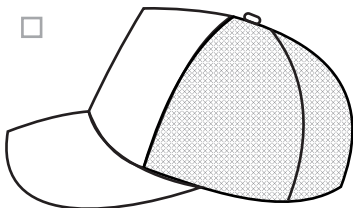

5 panels, Single front

Closure

plastic snap back

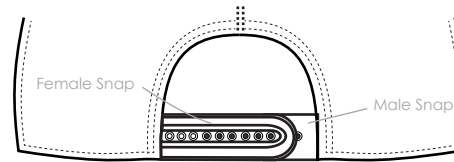

velco strap closure

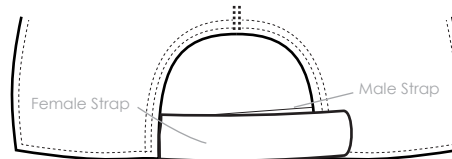

fabric/leather and metal closure

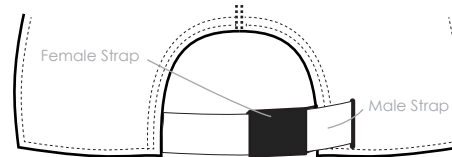

Closure: COLOR: MATERIAL:

Female
Male

Brim

PANEL: COLOR / SWATCH: FABRIC:

TOP VISOR

G

UNDER VISOR:

N

TYPE OF BRIM: FLAT Pre-curved

STYLE OF BRIM:

Regular Brim

Sandwich | Color:

Flip Visor

SHAPE OF BRIM:

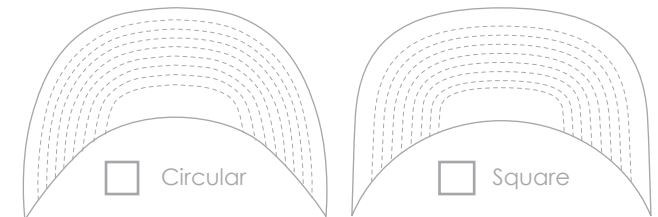

Number of Row stitches:
1 | 2 | 3 | 4 | 5 | 6 | 7 | 8

Exterior

PANEL: COLOR / SWATCH: FABRIC:

- A
- B
- C
- D
- E
- F

TOP BUTTON:

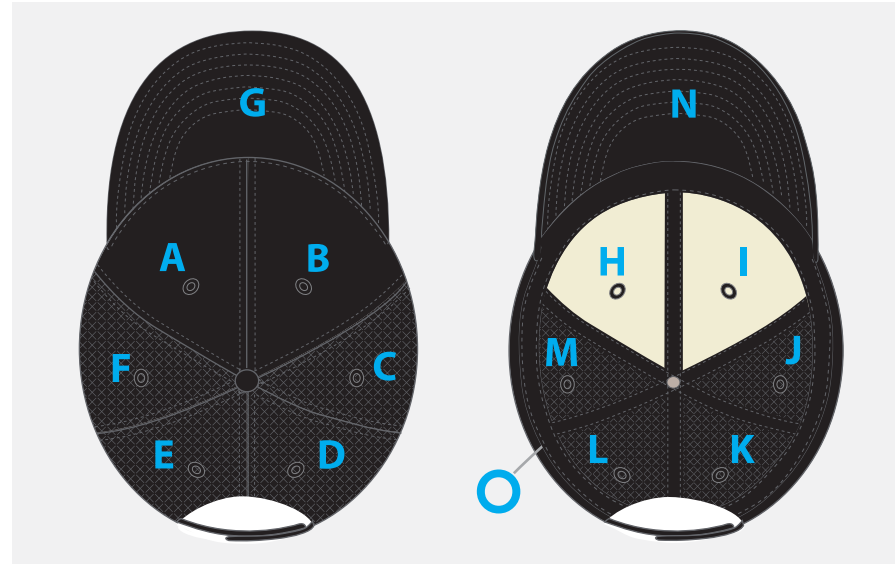

Sublimination

- A Yes, see attached art work
- B Yes, see attached art work
- C Yes, see attached art work
- D Yes, see attached art work
- E Yes, see attached art work
- F Yes, see attached art work
- G Yes, see attached art work
- N Yes, see attached art work

Interior Lining

PANEL: COLOR / SWATCH: FABRIC:

- H -
- I -
- J -
- K -
- L -
- M -

Pick one BUCKRAM: then pick one Double Single
 FOAM: Thin Thick

O - SWEATBAND:

Eyelets

PANEL: THREAD COLOR:

- A
- B
- C
- D
- E
- F

Crown Fitting

- Shallow Medium Deep

Stitching

PANEL: COLOR:

- A
- B
- C
- D
- E
- F

TOP VISOR:

G

UNDER VISOR:

N

(Optional) Front Clear Stitching

A & B Center clear stitching

Make stitching clear

A & B Bottom clear stitching

Make stitching clear

Taping

Type:

If Standard type pantone Color:



AUTHENTIC
CUSTOM | PRINTED
EST. 2015

Trucker
HAT

Product Details

Do you need embroidery? Yes No

How soon do you need the order to be delivered?

Do you have your artwork in svg, .eps, or .ai format? Yes No

If you don't have your artwork in a vector format do you have the image saved as a 300 dpi asset or greater?

Yes No Don't Know

Are you looking for our patent pending sublimation techniques? Yes No

How many **units** are you looking to order? Do you need to hire an artist? Yes No

Contact

Name: Phone number:

Email:

Notes

Agent: Discount Code:

How did you hear about us?