

Order Number: 000001

Project Name: Blank Template

CUSTOM MANUFACTURED SNAPBACK STYLE DESIGN EXAMPLE

FRONT VIEW

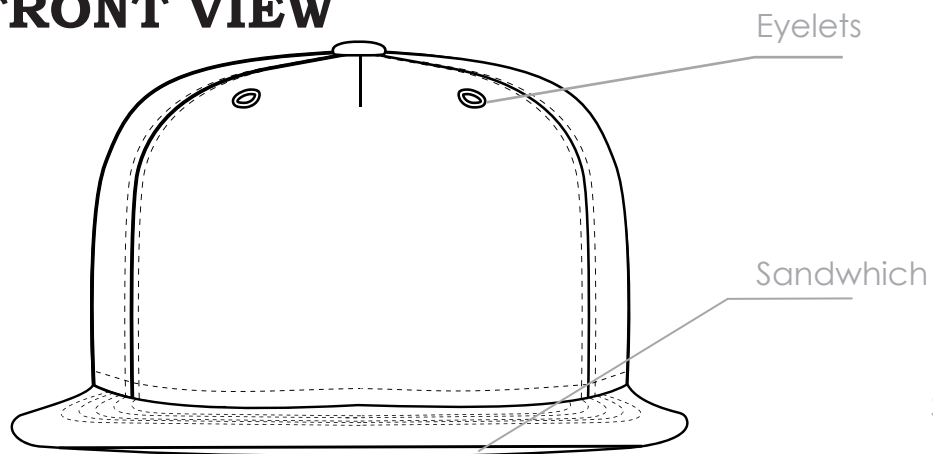

UNDER VIEW

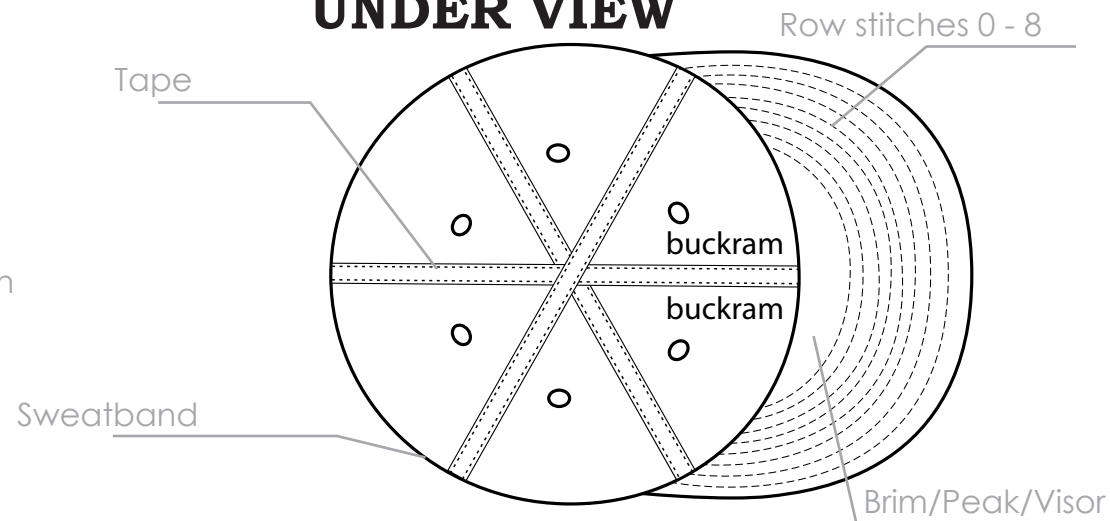

BACK VIEW

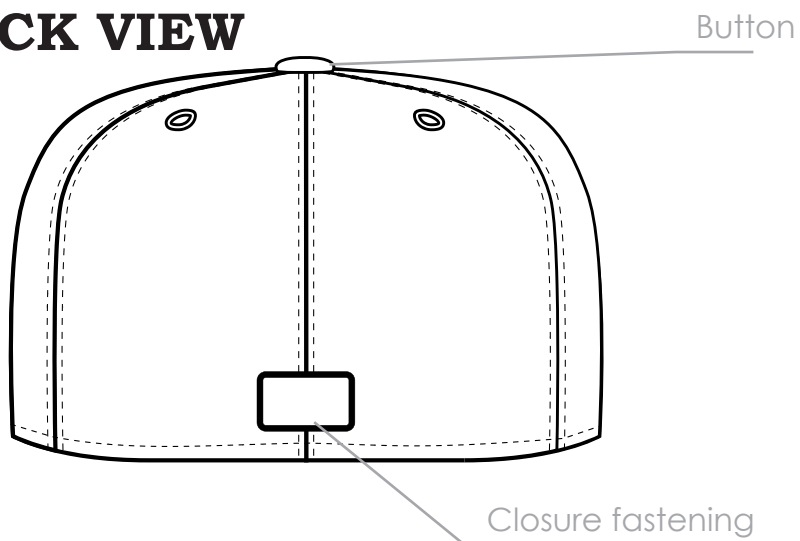

SIDE VIEW

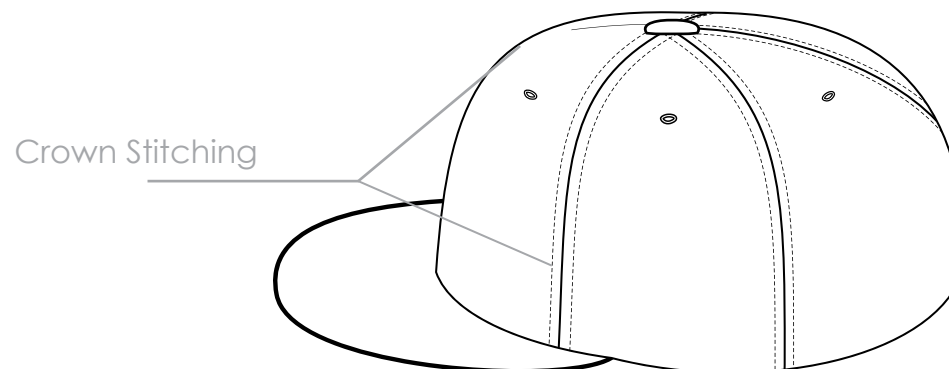

Order Number: 000001

Project Name: Blank Template

Crown Style

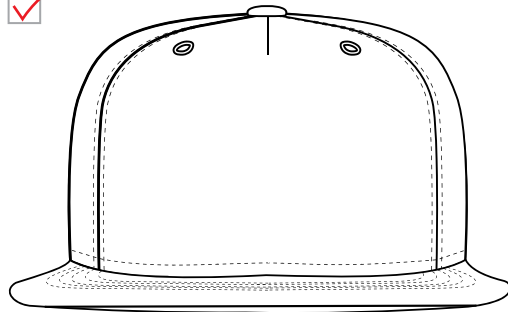

5 panels High Crown

Closure

plastic snap back

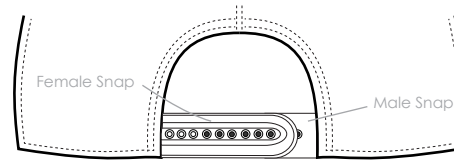

velco strap closure

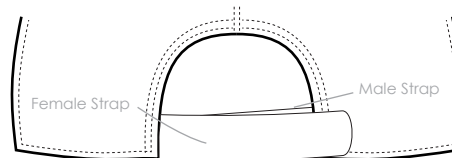

fabric/leather and metal closure

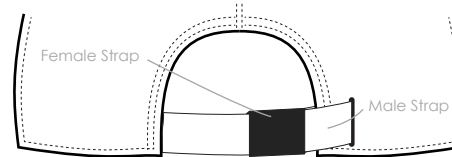

Closure: COLOR: MATERIAL:
Female Black Standard
Male Black Standard



*Optional Metal closure Stamp

Brim

PANEL: COLOR / SWATCH: FABRIC:

TOP VISOR

G type pantone here 100% cotton twill

UNDER VISOR:

N type pantone here 100% cotton twill

TYPE OF BRIM: FLAT Pre-curved

STYLE OF BRIM:

- Regular Brim
 Sandwich | Color:
 Flip Visor

SHAPE OF BRIM:

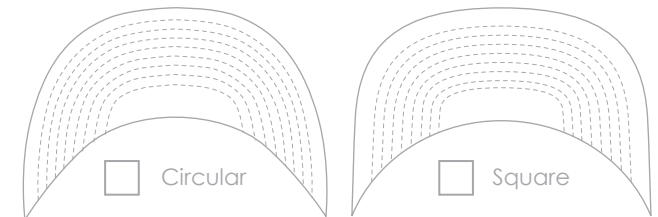

Number of Row stitches:

1 | 2 | 3 | 4 | 5 | 6 | 7 | 8

Order Number: 000001

Project Name: Blank Template

Exterior

PANEL: COLOR / SWATCH: FABRIC:

- A type pantone here 100% cotton twill
- C type pantone here 100% cotton twill
- D type pantone here 100% cotton twill
- E type pantone here 100% cotton twill
- F type pantone here 100% cotton twill

TOP BUTTON:

- type pantone here 100% cotton twill

Interior Lining

PANEL: COLOR / SWATCH: FABRIC:

- H - -
- I - -
- J - -
- K - -
- L - -
- M - -

BUCKRAM: Double Single

O SWEATBAND: black 3mm wrapped foam

Eyelets

PANEL: THREAD COLOR:

- A to match panel color
- C to match panel color
- D to match panel color
- E to match panel color
- F to match panel color

Fitting

- Shallow Deep

Stitching

PANEL: COLOR:

- A to match panel
- C to match panel
- D to match panel
- E to match panel
- F to match panel

TOP VISOR:

- G to match visor

UNDER VISOR:

- N to match visor

Sublimation

- A Yes, see attached art work
- B Yes, see attached art work
- C Yes, see attached art work
- D Yes, see attached art work
- E Yes, see attached art work
- F Yes, see attached art work
- G Yes, see attached art work
- N Yes, see attached art work

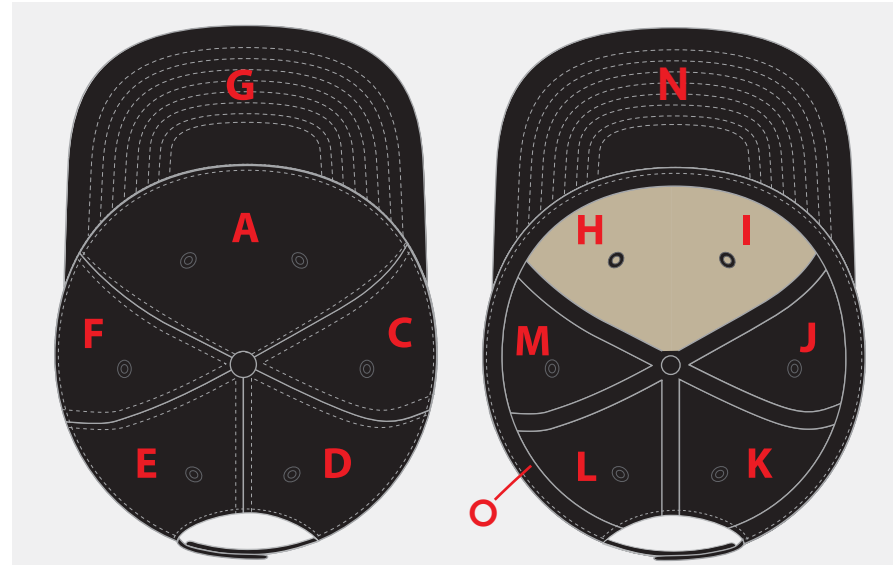

Order Number: 000001

Project Name: Blank Template

ADDITIONAL ARTWORK FILES:

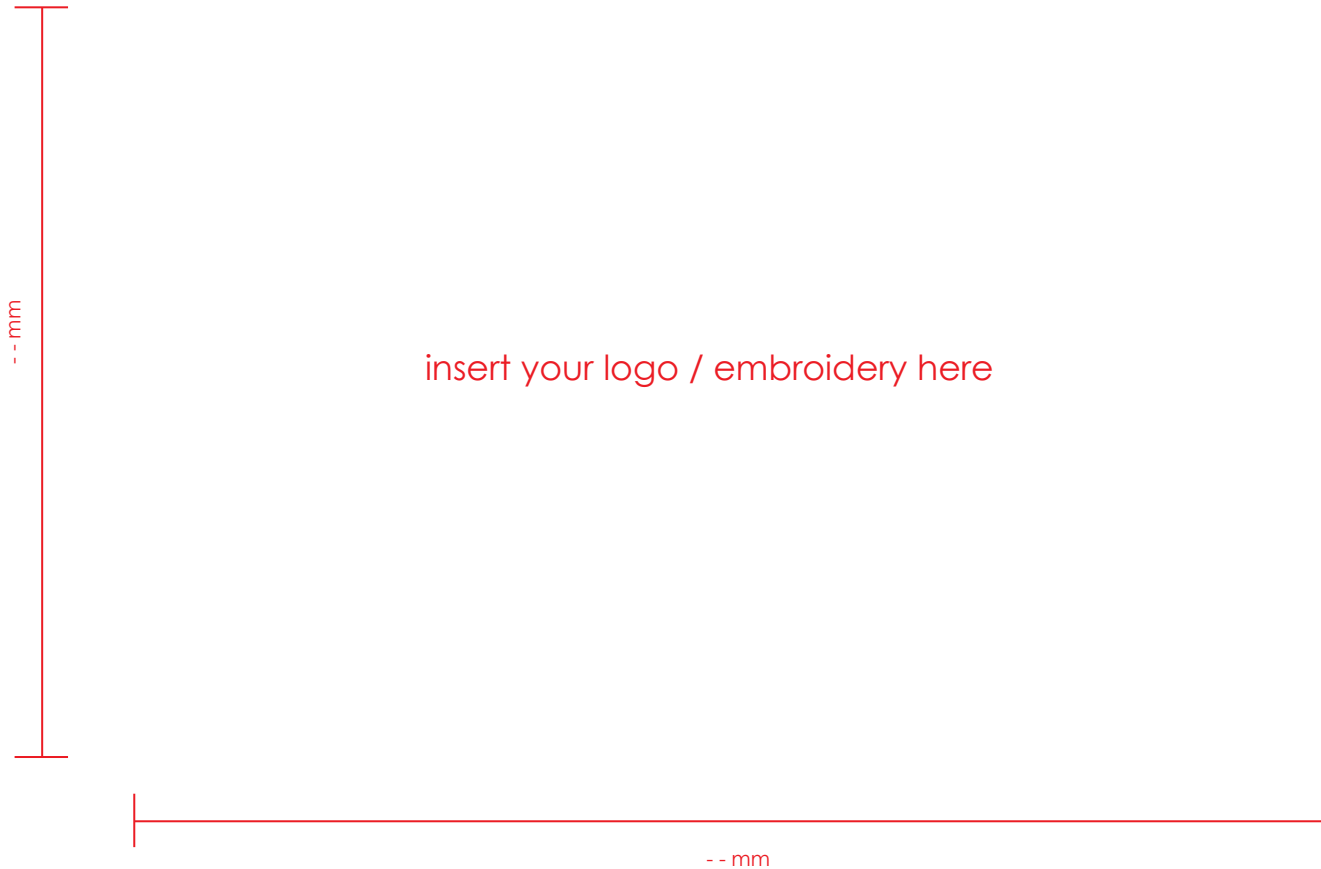

Front Panels

embroidery

EMBROIDERY TYPE: (3D / FLAT) SPECIFY THREAD COLORS:

- 3D type pantone here
- type pantone here
- type pantone here
- type pantone here

PLACEMENT:

Order Number: 000001

Project Name: Blank Template



Back and Side Panels

embroidery

EMBROIDERY TYPE: (3D / FLAT) SPECIFY THREAD COLORS:

- flat type pantone here
- type pantone here
- type pantone here
- type pantone here

PLACEMENT:

Other notes options, tags or addons.

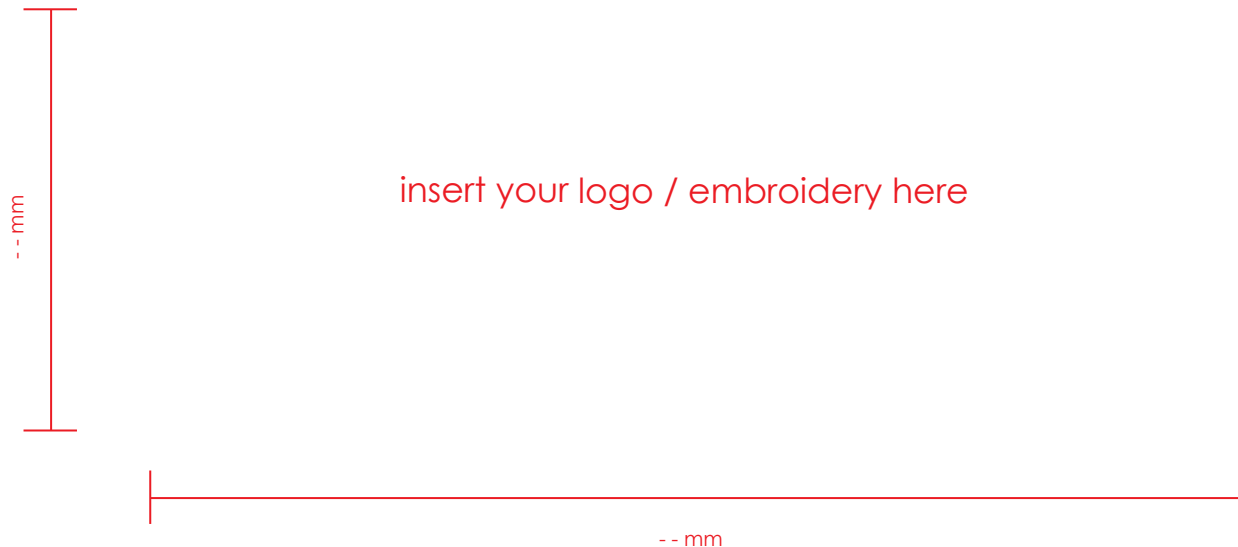

Order Number: 000001

Project Name: Blank Template

Custom panels

ADDITIONAL ARTWORK FILES:

If you have any custom fabric / prints please insert here. please also supply additional artwork file, with the art 100% to scale. If there is no panel customization, please just leave this section blank

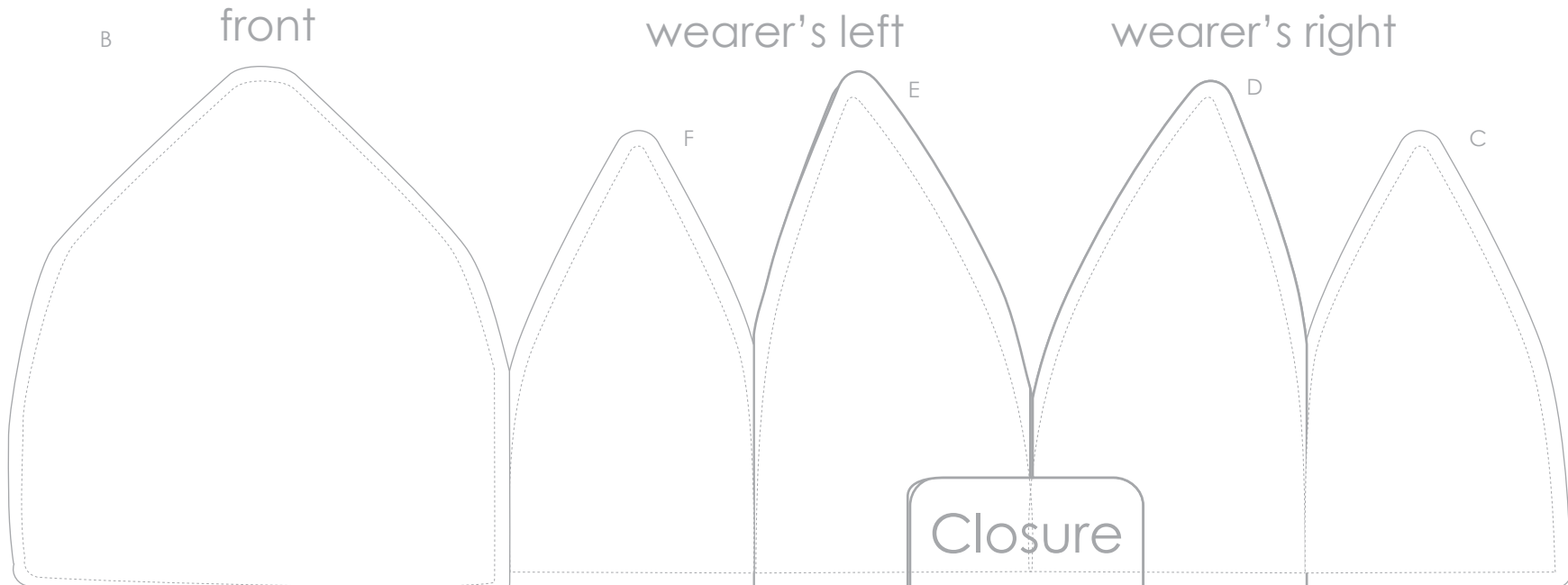
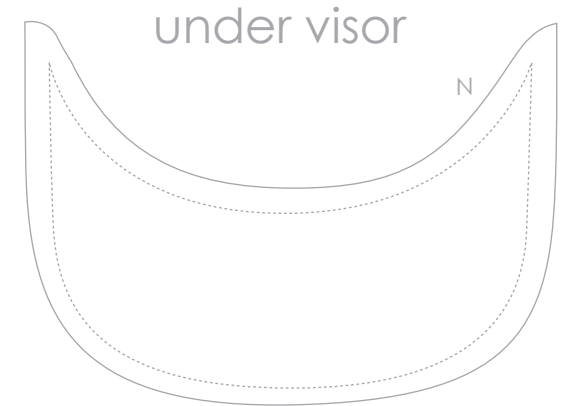



AUTHENTIC
CUSTOM | PRINTED
EST. 2015

5 Panel High Crown CAP

Order Number: 000001

Project Name: Blank Template

Interior Taping

TAPING COLOR: Black

SCREEN PRINT COLOR: Type pantone here Type pantone here



Additional Details

ADDITIONAL ARTWORK FILES:

Interior Labels

Cap Deals is a branded headwear manufacturer, At extra cost we can white label your tags. All headwear comes with our woven sweat band label if not white labeled.

Care Label





AUTHENTIC
CUSTOM | PRINTED
EST. 2015

5 Panel High Crown

CAP

Order Number: 000001

Project Name: Blank Template

Used for full Patterns & Wrap Designs only

Please be aware of the area that will be stitched together and could effect design.
Try to keep high detail away from edges. Wrapped designs will be matched to the best of our abilities.

Additional Details

ADDITIONAL ARTWORK FILES:

